

vtech[®]

Parent's Guide

KidiZoom[®]

CREATOR CAM



INTRODUCTION

Thank you for purchasing the **KidiZoom® Creator Cam** camera!

Get creative with all the built-in cool tools. With or without the included green screen, you can create photos and videos and save them to your computer. Use 20+ animated backgrounds and loads of special effects on this camera with the tripod/selfie stick included.

INCLUDED IN THIS PACKAGE



KidiZoom® Creator Cam

(With built-in rechargeable battery.
Battery is non-replaceable.)



Green screen fabric



Tripod/selfie stick



Micro-USB cable



Wrist strap

Note:

The metallic coating on the **KidiZoom® Creator Cam** is insulating.

WARNING:

All packing materials such as tape, plastic sheets, packaging locks, removable tags, cable ties and packaging screws are not part of this toy, and should be discarded for your child's safety.

NOTE:

Please keep this parent's guide as it contains important information.

ATTENTION :

Pour la sécurité de votre enfant, débarrassez-vous de tous les produits d'emballage tels que rubans adhésifs, feuilles de plastique, attaches, étiquettes et vis d'emballage. Ils ne font pas partie du jouet.

NOTE :

Il est conseillé de conserver ce guide des parents car il comporte des informations importantes.

The battery in this product must not be disposed of with household waste. This battery is recyclable. Please follow your local recycling regulations.

WARNING

Adult operation needed.

Unlock the Packaging Lock

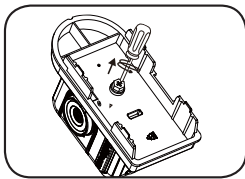

1. With a screwdriver, turn the packaging screw several times counterclockwise to loosen and remove.
2. Safely discard the screw and all packaging products.

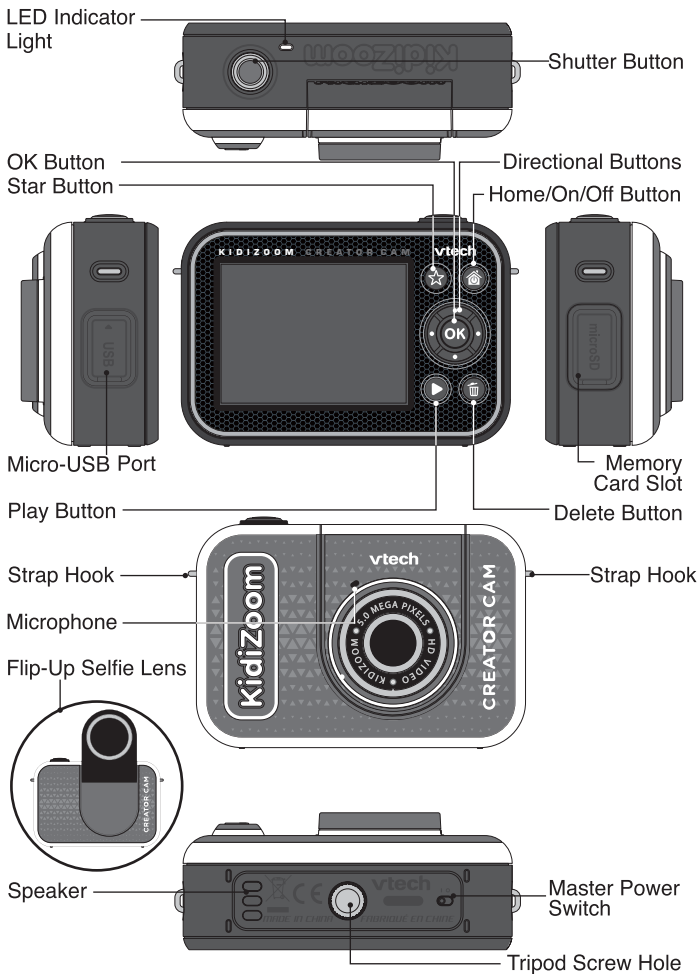



PRODUCT FEATURES

1. Master Power Switch

When the switch is set to the  position, the camera is disconnected from the battery and the battery will not charge. Move the switch to the  position to connect the camera to the battery and allow it to be recharged.

Note: The **Master Power Switch** is only for resetting the camera with a system reboot. When the camera is in daily use, you should leave the switch in the  position.

2. Shutter Button

Press this button to take a picture in photo modes or to start recording in video modes. When you're in another mode, pressing this button will take you to the Photo or Video mode.

3. Star Button

Press this button to change the volume. In Photo or Video modes, press this button to change camera options also.

4. Home/On/Off Button

Press to turn the camera **On**. Press and hold for two seconds to turn it **Off**. While the camera is **On**, press this button to go to the **Home** screen or to go back to the previous menu.

5. OK Button

Press this button to confirm a choice or action, or as a control in certain games.

Tip: The **OK** button can also be used as the **Shutter** button in Photo and Video modes.

6. Directional Buttons

Use these buttons to select options, or as controls in certain games.

7. Play Button

Press this button to review photos or movies.

8. Delete Button

Press this button to delete a photo or movie or to cancel an operation.

9. Memory Card Slot

Insert a microSD card here to expand the camera's memory. (MicroSD card not included.)

10. Micro-USB Port

Connect to a computer with the included **Micro-USB Cable** to transfer files to a computer and to charge the camera.

11. Flip-Up Selfie Lens

Flip up the lens to see yourself on-screen as you film and take pictures.

PRODUCT SPECIFICATIONS

Display	2.4" color LCD
Language	Multilingual (US English, UK English, Deutsch, Español, Français, Nederlands)
Photo Resolution	High Resolution Mode: 5MP (2560 x 1920) for regular photos 2MP (1600 x 1200) for photos with effects Low Resolution Mode: 0.3MP (640 x 480) Photo Saved From Video: 1280 x 720 / 640 x 360
Video Resolution	High Resolution Mode: 360p (640 x 360) for internal memory 720p HD (1280 x 720) for memory card Low Resolution Mode: 180p (320 x 180) for internal memory 360p (640 x 360) for memory card
Video Length Limit per File	30 minutes or up to 2 GB file size
Focus Range	1.5 feet - ∞
Internal Memory	256 MB built-in memory (shared with program data; actual memory available for user storage will be less)

Memory Card Format and Capacity	microSD / microSDHC card (not included) with capacity from 1 GB to 32 GB Class 10 or above is recommended
File Format	Photo: Standard baseline JPEG Video: AVI (Motion JPEG)
Connectivity	Micro-USB 2.0 cable (included) for connecting to a computer
Battery	Rechargeable lithium ion battery (battery is not replaceable)
Optimal Operating and Charging Temperature	32°F to 104°F (0°C to 40°C)

STORAGE CAPACITY FOR REFERENCE

		5 MP Photos	0.3 MP Photos	720p (HD) Video (Minutes)	360p Video (Minutes)	180p Video (Minutes)
Internal Memory		120	1,430	N/A	2	5
microSD Card	2 GB	1,800	21,500	10	20	N/A
	4 GB	3,700	43,000	20	50	
	8 GB	7,500	86,100	40	100	
	16 GB	15,100	172,300	80	210	
	32 GB	30,300	344,600	160	420	

Note: The above amounts are approximations. The actual capacity depends on the shooting environment.

The video length limit per file is 30 minutes. File size limit is up to 2 GB.

GETTING STARTED

When you use the **KidiZoom® Creator Cam** camera for the first time, switch the **Master Power Switch** to the  position.

When the **Master Power Switch** is in the  position, it is not possible to charge the camera or play any activities, and the system clock will be reset.

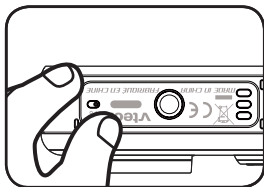

BATTERY CHARGING

Note: Adult operation required.

- Make sure the camera is not in use and the **Master Power Switch** is in the  position. Pull up the rubber cover over the **Micro-USB Port** on the side of camera.
- Insert the **Micro-USB Cable** (small end) into the **Micro-USB Port** on the camera.
- Insert the large end of the **Micro-USB Cable** into a USB port on a computer.
- When the battery is charging, a red LED will light up and you will see the battery charging icon.
- When the battery is fully charged, the LED will turn green, then the screen will turn off. Disconnect the camera from the power source.





Charging Guidelines

Only charge this device using the included micro USB cable connected to a computer. Do not charge using a third party adapter. Before use, inspect the cord to confirm that it is in good condition and that there are no breaks or exposed wires. Ensure there are no particles or liquid (water, juice, etc.) in either of the connectors before plugging in either end of the cable. The device should be completely dry with no debris in the cable connectors when charging. Plug in the cable securely, in the correct orientation. If the device is on when plugged in, a dialog box may open on your computer to allow you to access the device's drive. Never leave the device unattended while charging. Do not charge your device on soft surfaces, as they can trap heat around the device.

Typical charging time is between 3-4 hours if the battery is fully depleted. Disconnect the device when it is fully charged. Do not leave the device charging for more than 5 hours.

Note: The actual charging time depends on the charging current, the existing charge and the ambient temperature of the charging environment. The optimal ambient temperature is 32°F to 104°F (0°C to 40°C).

BATTERY LIFE

Like with other electronic devices, the more the camera is used, the more quickly the battery will drain. The battery will last approximately two hours with continuous use while taking photos and videos. With typical usage, the battery will last longer. The remaining battery capacity will display  in the top right corner of the screen. When the battery level is low , recharge the battery before further use. When the battery level is too low , the camera will not turn on until it is charged.

AUTOMATIC SHUT-OFF

To preserve battery life, the **KidiZoom® Creator Cam** will automatically shut off after a few minutes without input. When recording videos or using the time-lapse video function, the camera will not automatically turn off until the process completes.

BATTERY MAINTENANCE

Charge the camera regularly to keep it operating at optimal performance, even when the camera isn't in use. Be sure to charge the camera at least every six months.

BATTERY NOTICE

Misuse of batteries can lead to them bursting, causing a fire or chemical burns. Please follow these precautions:

- Do not disassemble the unit.
- Do not crush and do not expose the battery to any shock or force such as hammering, dropping or stepping on it.
- Do not short circuit.
- Do not expose to high temperatures or place near a heat source. Do not leave in direct sunlight for any length of time.
- Do not dispose of in fire.
- Do not handle damaged or leaking batteries.

- Keep the battery out of the reach of children.
- Keep the battery dry.
- Examine the battery charging cord periodically for conditions such as damage to the output cord, housing, or other parts that may result in the risk of fire, electric shock, or injury to persons. In the event of such conditions, the battery charging cord should not be used until properly repaired or replaced.
- If you find the time between charges is considerably shortened with no change in usage, the battery could be nearing the end of its life.

MEMORY CARD INSTALLATION

The **KidiZoom® Creator Cam** camera is compatible with microSD and microSDHC memory cards up to 32 GB. To install:

- Make sure the camera is **Off**.
- Open the cover over the **Memory Card Slot** on the side of the camera.
- Insert a memory card (not included) as illustrated. Once the memory card is detected, the memory card will automatically be used as the default memory.
- To remove the memory card from the camera, push the card once and it will eject.

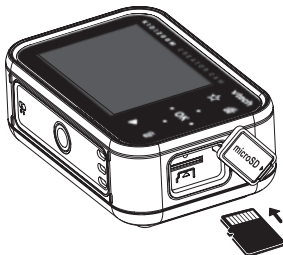

Note

- VTech recommends that you format your memory card before using it with the **KidiZoom® Creator Cam** camera.
- Data stored on the camera's internal memory will not be accessible while the memory card is in use. Be sure to back up all data to a computer regularly to prevent loss of photos and video.

GREEN SCREEN BACKGROUND SETUP (INDOOR USE RECOMMENDED)

Some of the features of the camera use the included **Green Screen** fabric. Parent assistance is required to safely secure the fabric. Depending on your home environment, the **Green Screen** can be hung any number of ways: with clothespins, binder clips, books or weights, sticky tack, thumb tacks and magnets are just a few ideas. Find a place to mount it where the camera can be positioned approximately three feet away, with room for your child to be safely in the middle. Hang the fabric so that the rougher side faces the camera. The camera's effects work best with even, cool white lighting and as few wrinkles in the cloth as possible. For best results, make sure that there are no shadows or direct sunlight falling on the Green Screen fabric.

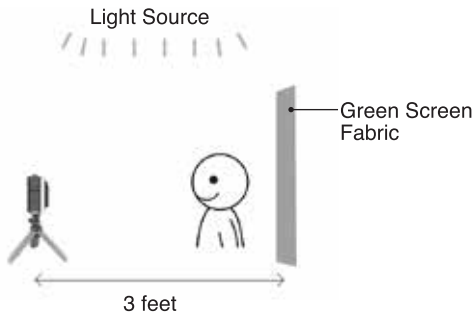













Note

If you see the video flickering, please make sure your Indoor Light Frequency is set correctly in the camera's Settings menu. (See the Settings section in this manual.) Also avoid having a direct light source pointing towards the camera.

TO BEGIN USING KIDIZOOM® CREATOR CAM



Make sure the **Master Power Switch** is in the  position and charge the camera before using.

Press the **Home/On/Off**  button to turn the camera **On**. When turning the camera **On** for the first time, you will be asked to select the language. Press the **Up**  or **Down**  buttons to select your desired language and press the **OK**  button to confirm.

Next, you will be asked to set the date and time. Use the **Directional**  buttons to set values. The **Up**  and **Down**  arrow icons will appear on the item to be adjusted. Press the **Up**  or **Down**  buttons or the **Left**  (or **Right** ) buttons to adjust values. Press the **OK**  button when all values are set.

Note: If the battery level is too low and cannot keep the clock running, enter the time and date again after recharging. If you wish to later change the language, date or time, you can do so from the **Settings** menu.

Home Menu



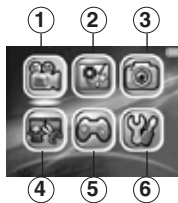

From the **Home** menu, you can access all of the modes on the **KidiZoom® Creator Cam** camera. Press the **Home**  button to display the **Home** menu. Then press the **Directional**  buttons to select a mode icon and press the **OK**  button to enter.

There are six modes:

1. Video
2. Green Screen Studio
3. Photo
4. Creativity Tools
5. Games
6. Settings











Adjust Speaker Volume

Press the **Star**  button to show the option panel. Select the **Speaker** icon  and press the **Left**  (or **Right** ) button to adjust the volume.

Video and Photo Playback

Press the **Play**  button to view your photos and videos.

- The most recent file will appear first. Press the **Up**  or **Down**  buttons to select the previous or next file.
- Press the **OK**  or **Play**  button to enlarge a photo to 2X or 4X or play a video. Press the **Delete**  button to delete the current file or choose to delete all photo and video files in the memory. Further confirmation is necessary to delete all photo and video files.
- While playing a video, press the **Left**  and **Right**  buttons to toggle fast-forward or fast-rewind functions at 1X, 2X, and 4X speeds. Press the **OK**  button to pause or resume playing.

Turning Off the KidiZoom® Creator Cam Camera

To turn the camera **off**, press and hold the **Home/On/Off**  button for two seconds. The camera will also automatically turn off after a few minutes without input.

TRANSFERRING FILES TO A COMPUTER

You can connect the **KidiZoom® Creator Cam** camera to a PC or Mac using the included **Micro-USB Cable**. Once a computer is connected, you can transfer files between the camera and computer. Please follow these steps:

- Insert the **Micro-USB Cable** (small end) into the **Micro-USB Port** on the camera.
- Insert the larger end of the **Micro-USB Cable** into a USB port on the computer.
- If your camera was off, wait until when you are asked to enter the Computer Connection mode, then select the check mark  to connect to the computer.
- On the computer, you will see a removable drive called VTech 5318. Please use this to transfer files to and from the camera. There is another removable drive called VT SYSTEM, which is for the storage of system data only. **Do not use or remove the VT SYSTEM drive.**

Note

Once the camera is connected to your computer, keep it connected while files are uploading or downloading. After you finish, safely eject the camera electronically from your computer and then physically disconnect the camera.

To avoid potential damage to your KidiZoom® Creator Cam, ensure the rubber cover over the Micro-USB Port is firmly closed when the camera is not connected to a cable.

To back up photos or videos:

- Open the DCIM folder on the removable drive VTech 5318.
- Drag and drop your photos or videos from their subfolders to a location on your computer to back them up.

To transfer photos or videos to KidiZoom® Creator Cam:

- Select the photo or video files you would like to upload from your computer first.
- Open the DOWNLOAD folder on the removable drive VTech 5318. Drag and drop your photos into the PHOTO folder, and videos into the VIDEO folder.

Note

Do not transfer photo or video files created by other cameras onto the KidiZoom® Creator Cam camera, as these file formats may not be compatible.

Minimum System Requirements

Microsoft® Windows® 8 or Windows® 10 Operating System, Mac OS X 10.10, 10.11, macOS 10.12 to 10.15.

USB port required.

Microsoft® and Windows logos are trademarks of Microsoft Corporation in the United States and other countries. Macintosh and Mac logos are trademarks of Apple Inc. in the United States and other countries. All other trademarks are the property of their respective owners.

USB Cable: The USB cable provided with this product complies with FCC and other regulatory emission limits. If using a USB cable other than the one provided, please note that in order not to exceed FCC and other regulatory emissions limits, a shielded cable must be used.









MODES



Video

Record Video



- Press the **Left** (and **Right**) buttons to cycle through video themes and effects.

- Press the **Shutter**  button or **OK**  button to start recording a video. Press either button to stop recording.
- Press the **Up**  or **Down**  button to take a photo.
- After recording completes, press the **OK**  button to play your video, or press the **Delete**  button to delete the video. When a video is playing, press the **OK**  or **Shutter**  button to skip review and return to Record mode.

Note

You can record 720p HD video only when a memory card is inserted and you have set the video resolution to High in **Settings**.

Timer Modes

In video preview screen, press the **Star**  button to pop up the option menu. In Timer mode , select Self-timer to use a 10 second countdown timer before video capture begins or select Face-timer to automatically start capturing when a stable face is detected.

The Timer mode will turn off every time the camera is switched off.

Microphone Volume

In camera preview screen, press the **Star**  button to pop up the option menu, press the **Up**  or **Down**  button to select the **Microphone** , then press the **Left**  (or **Right** ) button to adjust the **Microphone** volume.

Note

Increasing the **Microphone** volume will also increase the background noise on the video's soundtrack. The **Microphone** volume will reset to default every time the camera is switched off.



Green Screen Studio

Use the included **Green Screen** fabric in this mode to record videos in front of simulated backgrounds. Please refer to the earlier **Green Screen** fabric setup section for instructions on best placement of the fabric.

- Select a **Green Screen** theme and press **OK** to use it.
- In the video preview screen, press the **Shutter** or the **OK**  button to start recording. Press either button to stop recording.









- In the News Report theme, you can take an instant photograph or select a picture to customize your news background. You can also press the **Delete**  button and skip the picture selection, using a plain news background instead.
- The Weather Forecast theme allows you to set the weather for your report. Use the **Directional** buttons to choose weather icons and temperatures. The temperature range includes both the Fahrenheit and Celsius scales, although the symbols F and C do not appear.
- In Photo Background, you can select from the preset photos, select your own photo or take an instant photo to use for your background.









Note: Instant photographs will be removed once you quit Green Screen Studio and will not be saved.

Green Screen Detection Setting

By default, the camera automatically adjusts for best green screen detection for your lighting environment, but if you're ever having trouble you can adjust this setting manually. To do this, press the **Star**  button to pop up the option menu. Press the **Up**  or **Down**  button to select **Green Screen Detection Setting**  and then press the **Left**  or **Right**  button to try the different modes and find the one that works best for your conditions.

Photo

Take Photos



- Press the **Shutter**  button or **OK**  button to take a photo.
- Press the **Left**  (and **Right** ) buttons to cycle through different photo effects.
- Press the **Up**  and **Down**  buttons for 1X to 4X digital zoom.

Timer Modes

From the camera preview screen, press the **Star**  button to pop up the option menu. In Timer mode, select Self-timer to use a 10 second countdown timer before taking a photo or select Face-timer to automatically take a photo when a stable face is detected. The Timer mode will turn off every time the camera is switched off.





Creativity Tools

There are five modes in the Creativity Tools menu. Press the **Left**  (and **Right** ) buttons to choose a mode and press the **OK**  button to select.

- A. Invisibility Trick
- B. Video Editor
- C. Trick Video Maker
- D. Floating Object
- E. Time Lapse Video





A. Invisibility Trick (Green Screen Required)

In this mode you can use your **Green Screen** fabric to create invisibility illusions.

- First, find a background with nothing moving in it.
- Next, place your camera on the **Tripod** and press **OK**  to save the background image. Press **OK**  to confirm. Keep your camera completely still or your trick may fail.
- Finally, press the **Shutter** button to start recording. Now the **Green Screen** will reflect the background behind it. Hold the **Green Screen** in front of you to create the effect.





B. Video Editor

Use this mode to edit your videos. Press the **Up**  or **Down**  button to select a video to edit and select the check mark.  Press the **OK**  button to enter the editing screen. To view the video first, select the **Play**  icon.





Video Trimming

Press the **Directional**  buttons to select the new video start point and end point. The video parts excluded from between the two points will be removed.

Video Opening

Press the **Left**  (or **Right** ) button to select an intro and press the **OK**  button to confirm. The opening will be added to the beginning of your video.

Background Music

Press the **Left**  (or **Right** ) button to select a song to use as background music for your video and press the **OK**  button to confirm. The background music will be mixed with the original sound of the video. If you want the background music to be louder, press the **Up**  or **Down**  button to adjust its volume.

Play Video











Select this icon to preview the edited video before saving.



Save As

Once you're done editing, select this icon to save the final product as a new video.

C. Trick Video Maker



In this mode, you can record a video in two parts and create trick effects during the pause in recording.

- First, press the **Left**  (or **Right** ) button to select the duration of part 1 of the video. Press the **Shutter**  or the **OK**  button to start recording. It will stop automatically after the set duration, or press either button to stop recording at any time. 
- During the break while the camera's not recording, set up your trick. Try changing costumes, switching places with a friend, making props appear, or even disappearing.
- Next, you can press the **Up**  or **Down**  button to select a sound effect to be played at the beginning of part 2. Press the **Left**  (or **Right** ) button to select the duration of part 2 of the video and then make use of the transparent 

last frame from part 1 to align the action. Press the **Shutter**  or **OK**  button to resume recording. It will stop automatically after the set duration, or press either button to stop recording at any time.

D. Floating Object (Green Screen Required)

Use the **Green Screen** fabric in this mode to make objects appear to float in front of your videos.



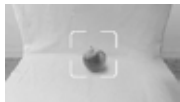





- First, pick an object that you'd like to create your illusion with. Make sure it's not green.
- Set the object on the **Green Screen** and press the **Shutter**  button to take a picture of it. You may want to drape the **Green Screen** fabric over a box or table to create a mini photo studio (see photo for example). Be sure to move the camera close to the object so that the **Green Screen** fills the entire background. Check your shot in camera preview mode before taking a picture.
- After taking a photo of the object, use the **Directional**  buttons to adjust the object's position on the screen.
- Finally, press the **Shutter**  button to record your video with the object appearing to float.



Tip: You can also use this mode to create a stamp or decoration for your videos!



E. Time Lapse Video

In this mode, you can set the camera to take photos at set time intervals and make a time lapse video from a maximum of 300 photos.



- Press the **Left**  (or **Right** ) button to select a time interval, then press the **OK**  button to enter the preview screen.
- Press the **Shutter**  button or **OK**  button to start recording.
- Press the **OK**  button or **Shutter**  button to stop recording, or it will stop automatically when the maximum number of time-lapse photos is reached, depending on the available memory.
- After recording completes, select background music and press **OK**  to save the time lapse video. You can review it after it's saved or view it later in **Play** mode. If you did not select any background music, you can add it to the saved video with the Video Editor later.

Note: With the maximum interval selected, the camera can record for up to five hours, so ensure it is fully charged before starting to record a time-lapse video.

Games



There are three built-in games on the **KidiZoom® Creator Cam** camera. Press the **Left** () and **Right** () buttons to choose a game and press the **OK** () button to play any of them.

1. Cake Master

Align the cake layers and press the **OK** () or **Down** () button to stack them perfectly and make an amazing cake!





2. River Cat

Press the **Left** () and **Right** () buttons to move or press the **OK** () button to jump to avoid obstacles and get through the river! Collect a turbo item to speed up or grab a floating ring for an extra life.



3. Bee Mission

Use the **OK** () or **Directional** () buttons to keep the bee flying to collect the target amount of honey. Be careful and avoid hitting the bugs and spider webs!



Settings

Press the **Left** () and **Right** () buttons to choose a setting to adjust.

A. Brightness

Press the **Up** or **Down** button to adjust the brightness of the LCD screen.

B. Memory

Review the status of the camera's internal memory or of the memory card (if one is inserted). There are two advanced options:

1. Format

This will erase all data in the internal memory or memory card (if one is inserted).

2. Factory Reset

Factory Reset will erase the contents (including photos, videos and files) stored in the internal memory and reset all system settings to factory default, such as the file index, camera settings and game level. Files in the memory card (if used) will not be erased.

Note: When a memory card is inserted, data stored in the internal memory cannot be accessed on the camera unless the memory card is removed. When the memory of the camera is getting full, or when the file indexes are used up, back up all the files to your computer and then delete all the files on your camera. To do this, either go to Settings and format the memory, or delete all photos and videos from Playback mode.

C. Camera Settings



This menu allows you to adjust various camera options. Press the **Up**  or **Down**  button to select an item and press the **OK**  button to toggle through the options.



Photo Resolution – Select between high or low photo quality captured by the camera.

Video Resolution – Select between high or low video quality captured by the camera.

NOTE: You must use a memory card to record video in 720p HD high video resolution setting.

Indoor Light Frequency – The default frequency is set according to your region. Please leave your camera set to the default value unless you are traveling.



D. Date & Time

To change the date or time, press the **OK**  button and use the **Directional**  buttons to adjust the settings and press **OK** to save.

E. Language

Choose from a list of available languages to change the text interface of the camera.

F. Parental Controls

The Parental Controls menu allows you to limit playtime for the games. Press and hold the **Star**  button until you see a pop-up message asking for a passcode. Use the **Directional**  buttons to enter the two-digit answer to the equation and press the **OK**  button to proceed. On the next screen, you can choose from the following options:

No Limit – This is the default option in which games can be played for any amount of time.

Disable Games – This will disable all games and the Games menu will be hidden from the Main menu.

15 / 30 / 60 / 90 minutes per day – When the accumulated game play time reaches the selected time limit, the player will not be able to play any games until the following day.

G. FCC Compliance Statement (US English only)

This page confirms that this product complies with FCC regulations.

CARE & MAINTENANCE

- Keep the rubber cover of the **Micro-USB Port** and **Memory Card Slot** tightly closed while the camera is not in use in order to prevent dust or water from getting into it.
- Keep the camera clean by wiping it with a slightly damp cloth.
- Turn the camera off at the **Master Power Switch** if it will not be in use for an extended period of time.
- Keep the camera out of direct sunlight and away from any direct heat source.
- Do not drop the camera on a hard surface and do not expose it to moisture or immerse it in water.
- Keep the **Lens** clean. If the images are blurry, it could be because there is dust or dirt on the **Lens**.

GREEN SCREEN FABRIC CARE



Machine Wash,
Gentle or Delicate
/ Lavage à la machine,
réglage délicat



Do Not Bleach
/ Ne pas javelliser



Do Not Tumble Dry
/ Séchage en
tambour interdit



Do Not Iron
/ Ne pas repasser



Do Not Dryclean
/ Nettoyage à sec interdit

WARNING

A very small percentage of the public, due to a pre-existing condition, may experience epileptic seizures or momentary loss of consciousness when viewing certain types of flashing colors or patterns.

While the **Kidizoom® Creator Cam** camera does not contribute to any additional risks, we do recommend that parents supervise their children

while they play games. If your child experiences dizziness, altered vision, disorientation, or convulsions, discontinue use immediately and consult your doctor. Please note that focusing on the **KidiZoom® Creator Cam** camera at close range and handling it as a game controller for a prolonged period of time may cause fatigue or discomfort. We recommend that children take a 15-minute break for every hour of play.

TRIPOD/SELFIE STICK ATTACHMENT

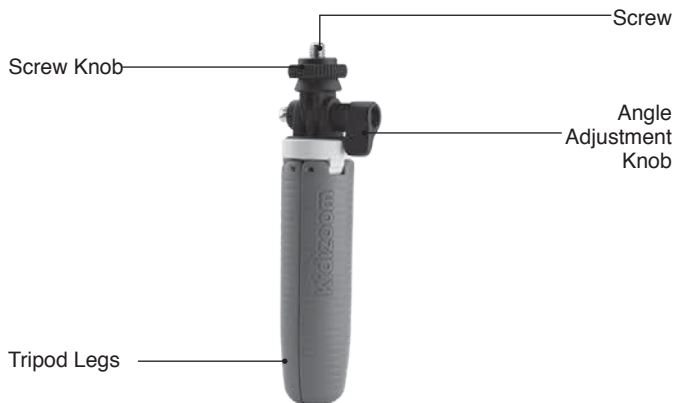

1. To mount the camera onto the **Tripod/Selfie Stick**, align the **Tripod Screw Hole** on the **KidiZoom® Creator Cam** with the screw of the **Tripod/Selfie Stick**. Screw the knob on the **Tripod/Selfie Stick** clockwise to affix the camera to the mount.



2. Loosen the **Angle Adjustment Knob** to rotate the angle adjustment arm and adjust the capture angle.
3. Tighten the **Angle Adjustment Knob** after you set the capture angle.

WRIST STRAP ATTACHMENT

1. Locate the thread loop on the end of the strap. Insert it into the **Strap Hook** and push through.
2. Feed the end of the strap up through the loop and pull it all the way through.
3. Pull gently to ensure the loop is securely tightened around the bar.

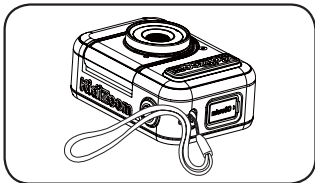

KIDIZOOM® CREATOR CAM FAQ

- Q - Can I use my own Green Screen instead of the included fabric?
- A - Yes, you can. For best results we recommend finding a fabric that's non-reflective and the same shade of green as the included Green Screen.
- Q - What are the best light settings for the green screen effects?
- A - The green screen effects work best with even, cool white lighting.
- Q - Can I use other pictures or videos as my own Green Screen background?
- A - You can use your own pictures as Green Screen still backgrounds by selecting the Photo Background theme in Green Screen Studio. For best results, make sure the image is 1280 x 720 Baseline JPG, and transfer it to the DOWNLOAD/PHOTO folder of the camera from your computer. The camera cannot use external videos as backgrounds.

TROUBLESHOOTING

Consult this section if you experience difficulty while operating your **KidiZoom® Creator Cam** camera.

Problem	Solution
The camera isn't working	<ol style="list-style-type: none">1. Turn the Master Power Switch off for 30 seconds.2. Turn the Master Power Switch on again and then press the Home button to turn it on. The camera should now work properly.3. If the camera still doesn't work, recharge the battery and try again.
Screen display is abnormal	<ol style="list-style-type: none">1. Turn the Master Power Switch off for 30 seconds.2. Turn the Master Power Switch on again and then press the Home button to turn it on. The screen display should be normal again.
Photos and videos aren't clear	<ol style="list-style-type: none">1. Make sure the lighting conditions of the shooting environment are adequate.2. Check to see if the Lens is clean.
Recorded video is not smooth	<ul style="list-style-type: none">• Check your memory card's performance. We recommend using a Class 10 or above microSD / microSDHC card. Using a memory card with lower performance may slow the video data-writing on the card and thus affect the video quality.• The performance of some memory cards will slow down after they have been used for a long time. If you have this problem, first back up your files and then re-format the card.
Cannot connect to computer	<ul style="list-style-type: none">• Check the connections on the USB cable between the camera and the computer and review the connection procedures in this manual.• Turn the Master Power Switch off for 30 seconds. Turn the Master Power Switch on and connect to the computer again.

<p>Flickering in recorded video</p>	<ul style="list-style-type: none"> • Check if the Indoor Light Frequency setting is correct. • Avoid having both sunlight and indoor lighting appear at the same time in your video composition.
<p>Colored dots appear in Green Screen Studio videos</p>	<ul style="list-style-type: none"> • Check if the Green Screen fabric is evenly lit. • Check if there are any wrinkles in your Green Screen fabric setup. • Check if the color of the room lighting is too warm or too cool. Try to change to a location with cool white color temperature lighting. • Try adjusting your Green Screen Detection Setting by pressing the Star button while filming.
<p>Memory card can't be detected</p>	<ul style="list-style-type: none"> • Check if the memory card is correctly inserted. • Check to see if the memory card is the supported type. The camera only supports microSD or microSDHC card. • Check to see if the file system of your memory card is FAT or FAT32. The KidiZoom® Creator Cam camera does not support NTFS or exFAT file systems. Be sure to back up all important data from your memory card and format it in either the FAT or FAT32 file system before using in your KidiZoom® Creator Cam.
<p>Can't view the downloaded video or photo files</p>	<p>Check if the downloaded files are in the correct directory on the KidiZoom® Creator Cam. Photos should be put in the DOWNLOAD/PHOTO folder, and videos should be put in the DOWNLOAD/VIDEO folder.</p> <p>KidiZoom® Creator Cam only supports these formats: Photos in Standard Baseline JPEG, and videos in AVI (Motion JPEG) created by the KidiZoom® Creator Cam camera.</p>

TECHNICAL SUPPORT

If you have a problem that cannot be solved by using this manual, we encourage you to visit us online or contact our Consumer Services Department with any problems and/or suggestions that you might have. A support representative will be happy to assist you.

Before requesting support, please be ready to provide the information below:

- The name of your product or model number (the model number is typically located on the back or bottom of your product).
- A description of the problem you are experiencing.
- The actions you took right before the problem started.

Internet: vtechkids.com/support

Phone: 1-800-521-2010 in the U.S. or 1-877-352-8697 in Canada



WARNING:

**CHOKING HAZARD-SMALL PARTS.
NOT FOR CHILDREN UNDER 3 YRS.**

**CLASS 1
LED PRODUCT**

DISCLAIMER AND LIMITATION OF LIABILITY

VTech® Electronics North America, L.L.C. and its suppliers assume no responsibility for any damage or loss resulting from the use of this handbook. VTech® Electronics North America, L.L.C. and its suppliers assume no responsibility for any loss or claims by third parties that may arise through the use of this product. VTech® Electronics North America, L.L.C. and its suppliers assume no responsibility for any damage or loss caused by deletion of data as a result of malfunction, dead battery, or repairs.

IMPORTANT NOTE:

If the problem persists, please call our Consumer Services Department at 1-800-521-2010 in the U.S., 1-877-352-8697 in Canada, or visit our website vtechkids.com and fill out our Contact Us form located under the Customer Support link. Creating and developing VTech® products is accompanied by a responsibility that we at VTech® take very seriously. We make every effort to ensure the accuracy of the information which forms the value of our products. However, errors sometimes can occur. It is important for you to know that we stand behind our products and encourage you to call our Consumer Services Department at 1-800-521-2010 in the U.S., or 1-877-352-8697 in Canada with any problems and/or suggestions that you might have. A service representative will be happy to help you.

CAUTION

Changes or modifications not expressly approved by the party responsible for compliance could void the user's authority to operate the equipment.

NOTE

This equipment has been tested and found to comply with the limits for a Class B digital device, pursuant to Part 15 of the FCC Rules. These limits are designed to provide reasonable protection against harmful interference in a residential installation. This equipment generates, uses and can radiate radio frequency energy and, if not installed and used in accordance with the instructions, may cause harmful interference to radio communications. However, there is no guarantee that interference will not occur in a particular installation.

If this equipment does cause harmful interference to radio or television reception, which can be determined by turning the equipment off and on, the user is encouraged to try to correct the interference by one or more of the following measures:

- Reorient or relocate the receiving antenna.
- Increase the separation between the equipment and receiver.
- Connect the equipment into an outlet on a circuit different from that to which the receiver is connected.
- Consult the dealer or an experienced radio/TV technician for help.

Supplier's Declaration of Conformity
47 CFR § 2.1077 Compliance Information

Trade Name: VTech®
Model: 5318
Product Name: KidiZoom® Creator Cam
Responsible Party: VTech Electronics North America, LLC
Address: 1156 W. Shure Drive, Suite 200, Arlington Heights, IL 60004
Website: vtechkids.com

THIS DEVICE COMPLIES WITH PART 15 OF THE FCC RULES. OPERATION IS SUBJECT TO THE FOLLOWING TWO CONDITIONS: (1) THIS DEVICE MAY NOT CAUSE HARMFUL INTERFERENCE, AND (2) THIS DEVICE MUST ACCEPT ANY INTERFERENCE RECEIVED, INCLUDING INTERFERENCE THAT MAY CAUSE UNDESIRE OPERATION.

CAN ICES-3 (B)/NMB-3(B)

To access the above compliance statement from the product software:

1. In the **Main Menu**, select the **Settings** menu icon .
2. In the **Settings** menu, select the **FCC Compliance Statement** page .

The FCC Compliance Statement page is only available in the US English version of the program. To change the language version, please refer to the Settings section of this Parent's Guide.

***Visit our website for more
information about our products,
downloads, resources and more.***

vtechkids.com

Read our complete warranty policy online at
vtechkids.com/warranty

